PRODUCT SPECIFICATION

MODEL: JW070R0520B02

< ◇ > PRELIMINARY SPECIFICATION

< ◆ > APPROVAL SPECIFICATION

CUSTOMER
APPROVED BY
DATE:

DESIGNED	CHECKED	APPROVED

REVISION STATUS

Version	Revise Date	Page	Content	Modified by
V1.0	2019.03.26	-	First Issued.	Jason

CONTENTS

1. GENERAL DESCRIPTION	P.4
2. MECHANICAL SPECIFICATION	P.5
3. PIN DESCRIPTION.....	P.6
4. BLOCK DIAGRAM.....	P.7
5. ELECTRICAL CHARACTERISTICS	P.8
6. INPUT SIGNAL CHARACTERISTICS	P.11
7. OPTICAL CHARACTERISTICS	P.13
8. RELIABILITY TEST	P.16
9. GENERAL PRECAUTION	P.17
10. PACKAGE DRAWING.....	P.18

1. GENERAL DESCRIPTION

1.1 DESCRIPTION

JINGWEI Display model JW070R0520B02 is a transmissive type color active matrix liquid crystal display (LCD) which uses amorphous thin film transistor (TFT) as switching devices. This product is composed of a TFT LCD panel, driver ICs and a backlight unit. The following table describes the features of this LCM.

1.2 FEATURES

No.	Item	Specification	Unit
1	Panel Size	7	inch
2	Number of Pixels	1024 × 3(RGB) ×600	pixels
3	Active Area	154.2144(H) ×85.92(V)	mm
4	Pixel Pitch	0.1506(H) ×0.1432(V)	mm
5	Outline Dimension	165(H) × 100(V) × 3.5(D)	mm
6	Pixel arrangement	RGB - stripe	-
7	Display Mode	IPS with Normally Black	-
8	Viewing Direction	ALL Viewing Direction	-
9	Display Color	16.7M	-
10	Interface	LVDS	-
11	Backlight	White LED	-
12	Drive IC	-	-
13	Operation Temperature	-20~70	°C
14	Storage Temperature	-25~75	°C
15	Weight	116(Typ.)	g

2. MECHANICAL SPECIFICATION

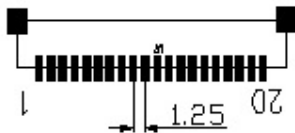
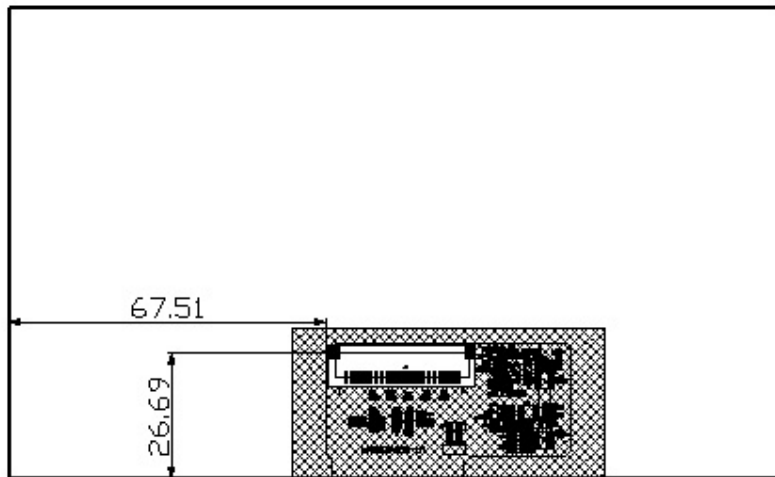
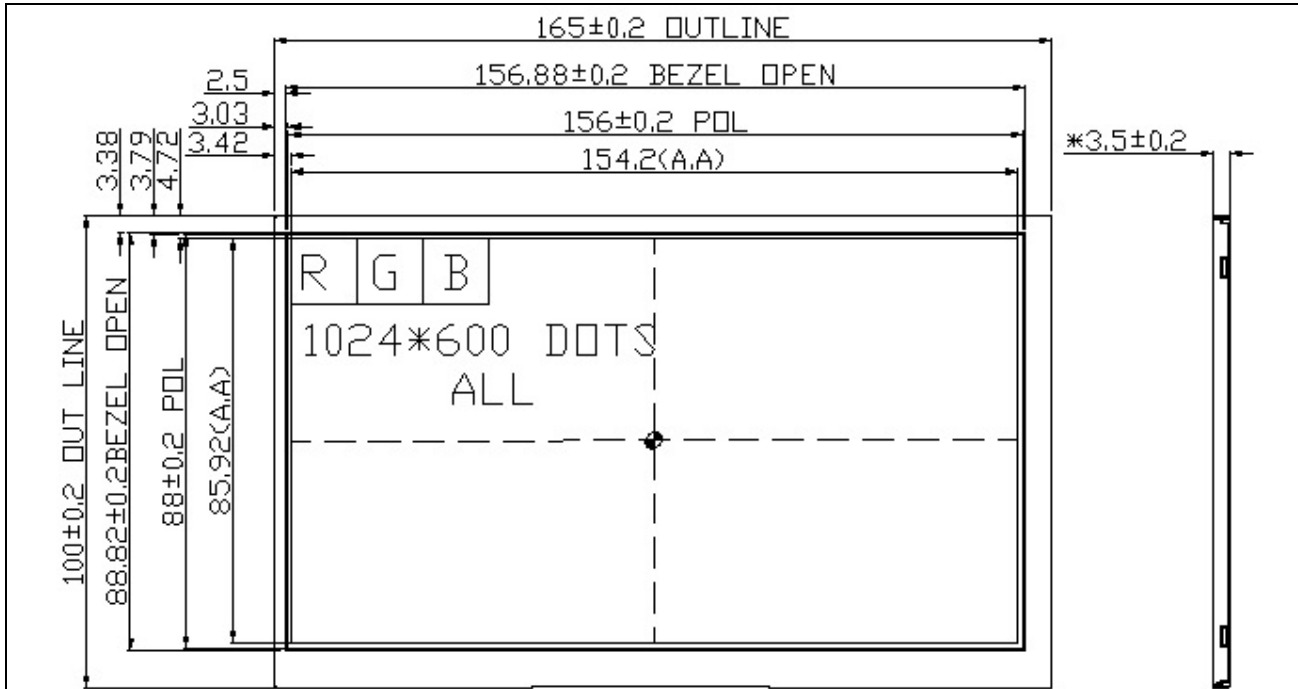

REVISION	A0	MODEL NO	APPROVEDBY	CHECKEDBY	DRAWNBY
DATE	2019-03-26	JW070R0520B02			
PAGE	1/1				

3. PIN DESCRIPTION

3.1 CN1 of FPC

Pin No.	Symbol	I/O	Function	Remark
1	VDD	P	Power supply VDDIN=3.3V	
2	VDD	P	Power supply VDDIN=3.3V	
3	LED_EN	I	Power supply VDDIN(3.3~5.0V)	
4	GND	P	Ground	
5	RXIN0N	I	0-LVDS differential data	
6	RXIN0P	I	0+LVDS differential data	
7	GND	P	Ground	
8	RXIN1N	I	1-LVDS differential data	
9	RXIN1P	I	1+LVDS differential data	
10	GND	P	Ground	
11	RXIN2N	I	2-LVDS differential data	
12	RXIN2P	I	2+LVDS differential data	
13	GND	P	Ground	
14	RX_CLKN	I	-LVDS differential clock input	
15	RX_CLKP	I	+LVDS differential clock input	
16	GND	P	Ground	
17	RXIN3N	I	3-LVDS differential clock input	
18	RXIN3P	I	3+LVDS differential clock input	
19	PWM	I	Backlight brightness:apply 0.7V to 1.4V DC voltage signal	
20	VLED	P	Power supply VLED=5~12V(Typ.)	

Note: I/O definition:

I: input, O: output, P: Power, -:No Connection

4. BLOCK DIAGRAM

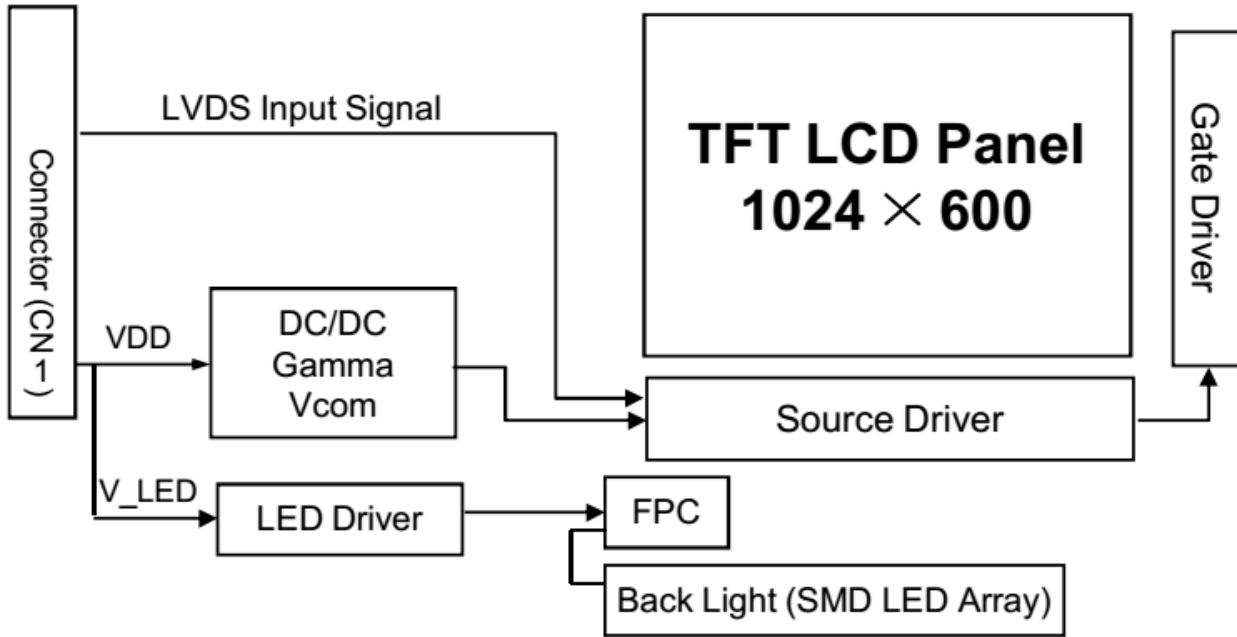

5. ELECTRICAL CHARACTERISTICS

5.1 ABSOLUTE MAXIMUM RATINGS

AGND=GND=0V, Ta = 25 °C

Item	Symbol	Values		Unit	Remark
		Min.	Max.		
Power voltage	VDD-VSS	-0.5	4.0	V	
	VLED -VSS	-0.5	12	V	

5.2 RECOMMENDED OPERATING CONDITION

AGND=GND=0V, Ta = 25°C

Item	Symbol	Values			Unit	Remark	
		Min.	Typ.	Max.			
Digital Supply Voltage	VDD	3.0	3.3	3.6	V	-	
Power Supply for LED	VLED	4.8	5	12	V	-	
Power IC provides voltage	AVEE	-6	-5	-4.5	V	-	
	AVDD	4.5	5.5	6.0	V	-	
Driver IC provides voltage internally	VGH	9	-	20	V	-	
	VGL	-20	-	-9	V	-	
Input Signal Voltage	Low Level	VIL	0	-	0.3*VDD	V	-
	High Level	VIH	0.7*VDD	-	VDD	V	

5.3 POWER SEQUENCE

5.3.1 Power on sequence

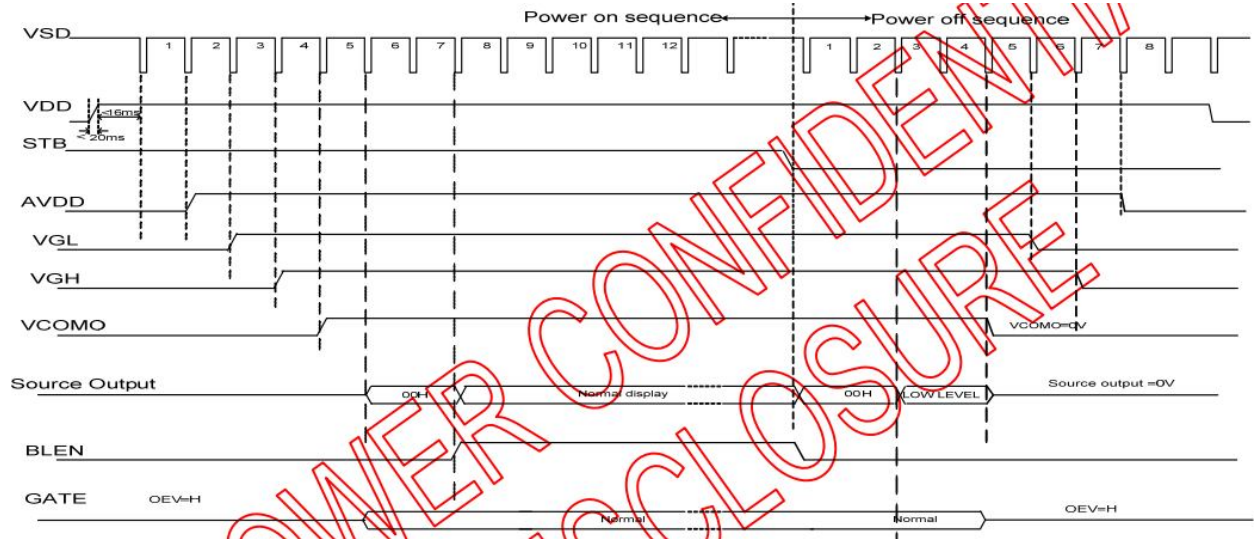

5.3.2 Power off sequence

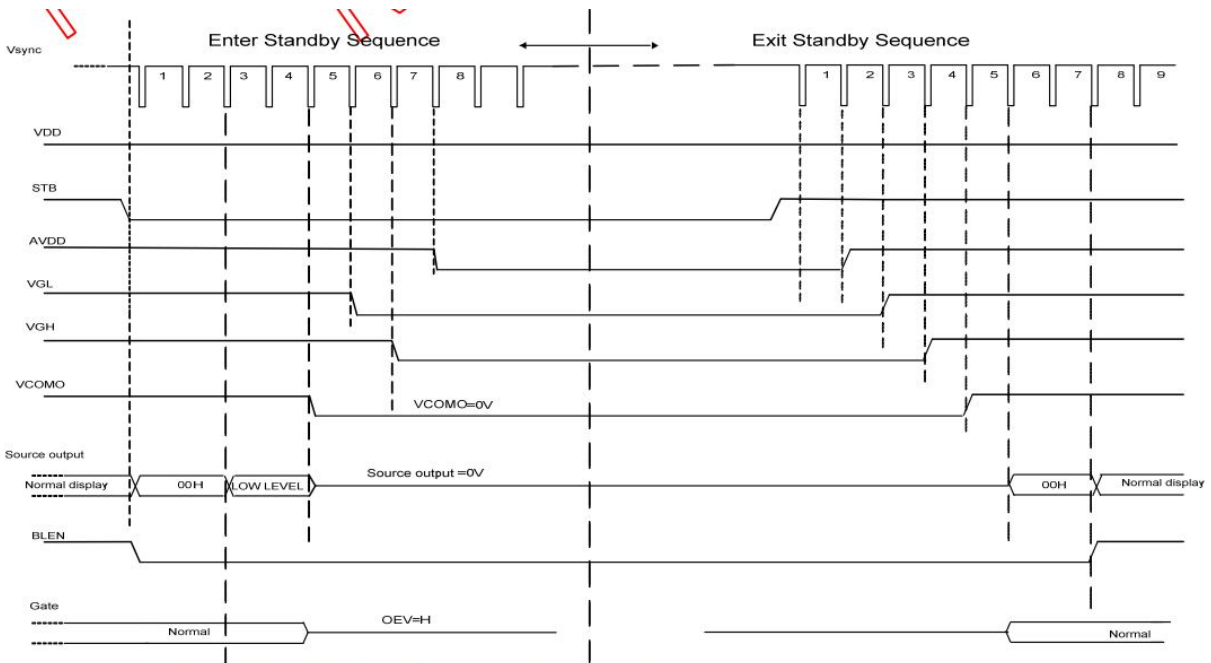

Note: Low Level=3Fh, when NBW="L" (Normally white)
 Low Level=00h, when NBW="H" (Normally Black)

5.4 BACKLIGHT UNIT

Item	Symbol	Values			Unit	Remark
		Min.	Typ.	Max.		
Forward voltage	VF	25.6	27	29.1	V	IF=20mA/1-chip
Forward current	If	55	60	65	mA	
PWM Signal Voltage	PWM_h	2.0	3.3	3.6	V	-
PWM Signal Voltage	PWM_l	0	-	0.5	V	-
Output PWM frequency	PWM_f	-	200	20K	Hz	-
LED enable Voltage	EN_h	2.6	3.3	3.6	V	-
	EN_l	0	-	0.4	V	-

5.4.1 Internal Circuit Diagram

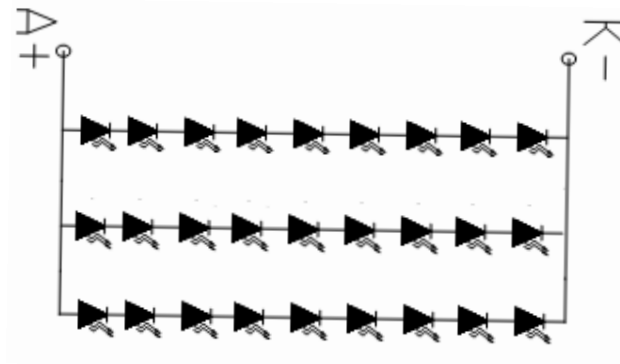

CURRENT IF=60mA

Item	Symbol	Values			Unit
		Min.	Typ.	Max.	
LED Life Time	LBL	10000	-	-	Hrs

6. INPUT SIGNAL CHARACTERISTICS

6.1. INPUT TIMING TABLE

Item	Symbol	Values			Unit	Remark
		Min.	Typ.	Max.		
DCLK	FCLK	40.8	51.2	71	MHz	-
Hor.	Thd	1024			dclk	-
HSD period	th	1114	1344	1464	dclk	-
HSD blanking	T _{hb} + T _{hfp}	90	320	376	dclk	-
Ver.	T _{vd}	600			Th	-
VSD period	T _v	610	635	800	Th	-
VSD blanking	T _{vbp} + T _{hfp}	-	24	-	Th	-

DE mode

Horizontal input timing

Parameter	Symbol	Spec.			unit
		min	typ	max	
DCLK	Fclk	44.9	51.2	71	MHz
Hor.	Thd	1024			dclk
HSD Line	Th	1200	1344	1464	dclk
HSD pulse width	Thpw	1	-	140	dclk
HSD blanking	Thb	160	160	160	dclk
HSD porch	Thfp	16	160	216	dclk

HV mode

Vertical input timing

Parameter	Symbol	Spec.			unit
		min	typ	max	
VSD Vertical	tv _d	-	600	-	H
VSD period time	tv	624	635	800	H
VSD pulse width	tv _{pw}	1	-	20	H
VSD back porch	tv _b	23	23	23	H
VSD front porch	tv _{fp}	1	12	177	H

HV mode

6.2. LVDS INTERFACE

6.2.1. Data input format for LVDS

6-bit LVDS input(LVBIT="L",LVMT=Don't Care)

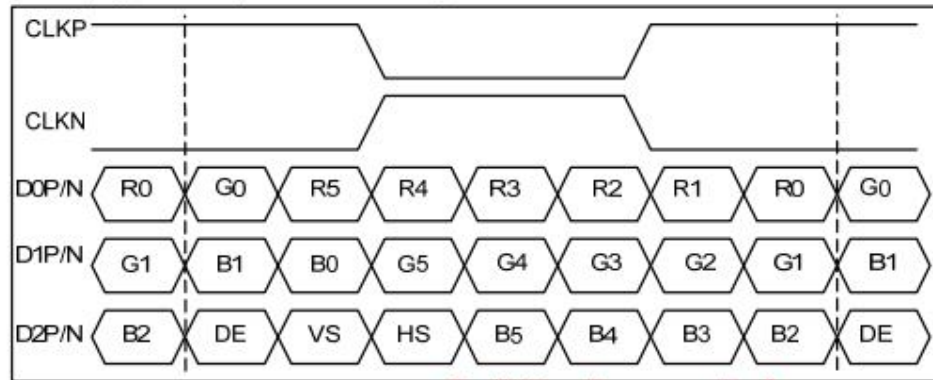

8-bit LVDS input(LVBIT="H",LVFMT="H")-JEIDA

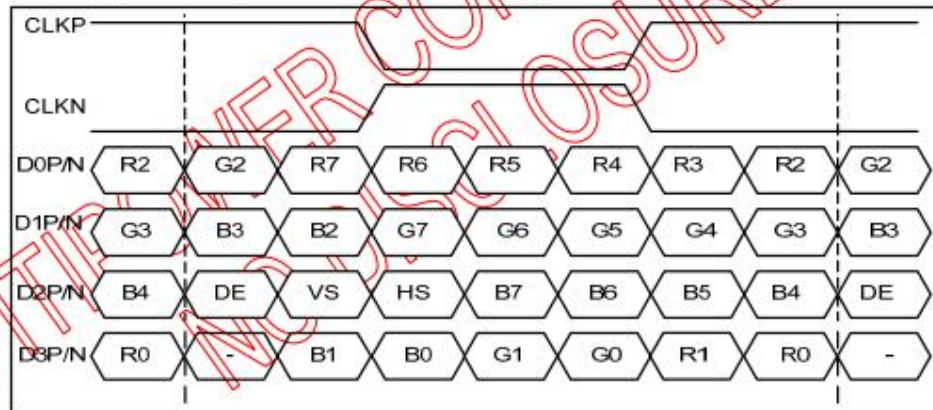

8-bit LVDS input(LVBIT="H",LVFMT="L")-VESA

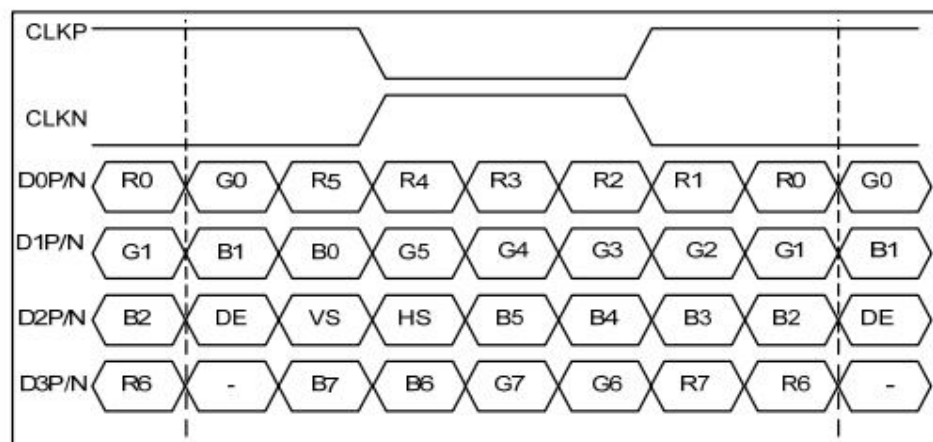

7. OPTICAL CHARACTERISTICS

Light source :c-light(with normal polarizer)

Item	Symbol	Condition	Values			Unit	Remark	
			Min.	Typ.	Max.			
Viewing angle	Θ_U	$CR \geq 10$	-	85	-	degree	Note2	
	Θ_D		-	85	-			
	Θ_L		-	85	-			
	Θ_R		-	85	-			
Response time	$T_{ON}+T_{OFF}$	$\theta=\phi =0^\circ$ Normal viewing angle	-	19	25	ms	Note1 Note3	
Contrast ratio	CR		400	500	-	-	Note1 Note4	
Luminance	L		280	300	320	cd/m ²		
Luminance uniformity	YU		70	75	-	%		
Color chromaticity (CIE1931)	White		WX	0.276	0.296	0.316		Note1 Note5
			WY	0.312	0.332	0.352		
	Red		RX	-	-	-		
			RY	-	-	-		
	Green	GX	-	-	-			
		GY	-	-	-			
	Blue	BX	-	-	-			
		BY	-	-	-			

Test Conditions:

- 1.Measuring surrounding:dark room
- 2.The ambient temperature is $25\pm 2^\circ\text{C}$.
- 3.The test systems refer to Note1 and Note2.

Note1: Definition of optical measurement system

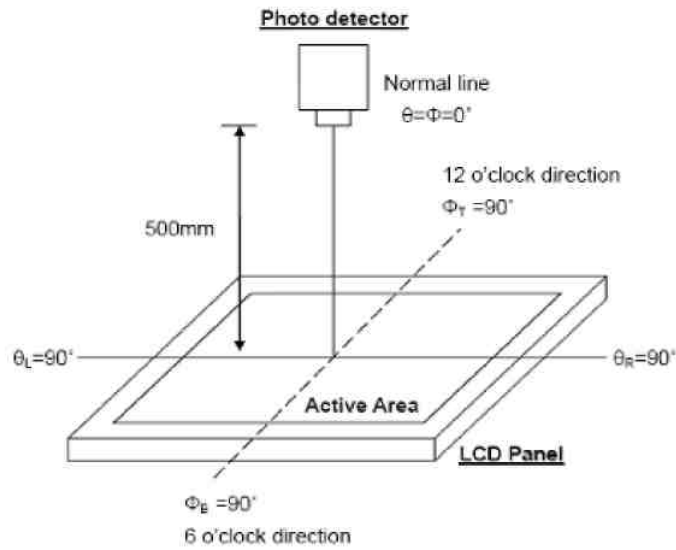

Note2: Definition of viewing angle range and measurement system

Viewing angle is measured at the center point of the LCD by CONOSCOPE (ergo-80).

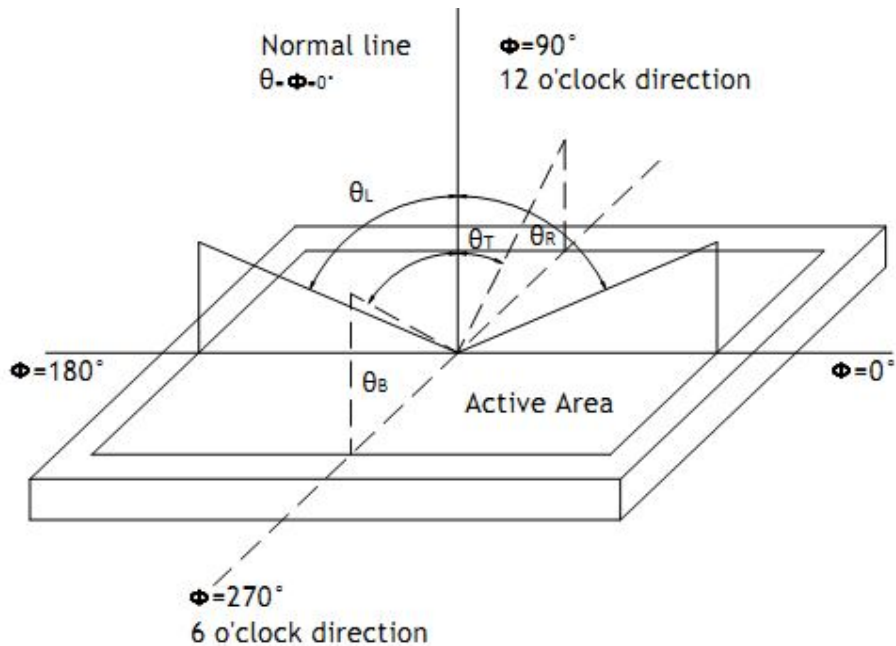

Note3: Definition of Response time

The response time is defined as the LCD optical switching time interval between "White" state and "Black" state. Rise time (TON) is the time between photo detector output intensity changed from 90% to 10%. And fall time (TOFF) is the time between photo detector output intensity changed from 10% to 90%.

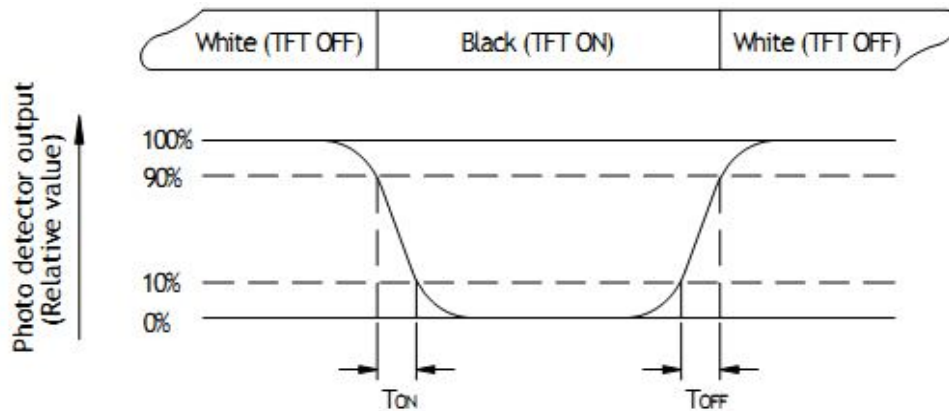

Fig. 6-3 Definition of response time

Note4: Definition of contrast ratio

$$\text{Contrast ratio (CR)} = \frac{\text{Luminance measured when LCD on the Whitestate}}{\text{Luminance measured when LCD on the Blackstate}}$$

“White state “: The state is that the LCD should drive by V_{white} .

“Black state“: The state is that the LCD should drive by V_{black} .

V_{white} : To be determined V_{black} : To be determined.

Note5: Definition of color chromaticity (CIE1931)

Color coordinates measured at center point of LCD.

Note6: All input terminals LCD panel must be ground while measuring the center area of the panel.

The LED driving condition is $I_L=20\text{mA}$ of which each LED module is 3 LED serial.

Note7: Definition of Luminance Uniformity

Active area is divided into 9 measuring areas. Every measuring point is placed at the center of each measuring area.

$$\text{Luminance Uniformity (U)} = L_{\text{min}} / L_{\text{max}}$$

L----Active area length, W---- Active area width

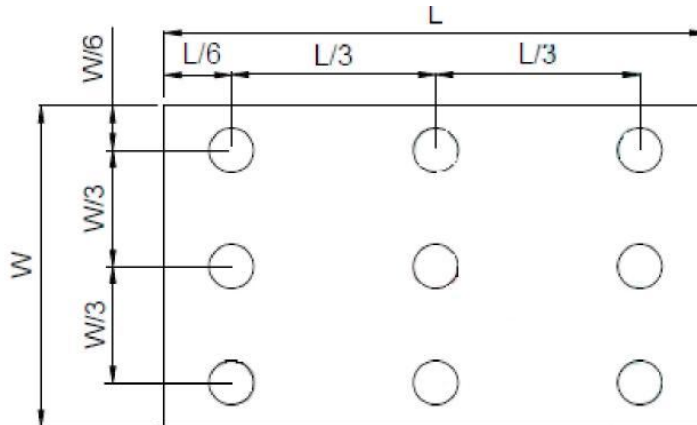

B_{max} : The measured maximum luminance of all measurement position.

B_{min} : The measured minimum luminance of all measurement position.

Note8: Definition of Luminance

Measure the luminance of white state at center point.

8. RELIABILITY TEST

8.1 TEMPERATURE AND HUMIDITY

Test Item	Test Condition
High Temperature Storage	Ta=60°C; 240hrs
Low Temperature Storage	Ta=-20°C; 240hrs
High Temperature Operation	Ta=50°C ; 240hrs
Low Temperature Operation	Ta=0°C; 240hrs
High Temperature High Humidity Operation	Ta=60°C ; 90%RH ; 240hrs(no condensation)
Thermal Shock	-20°C(0.5hrs) ~ 60°C(0.5hrs) / 100 cycles
Image Sticking	25°C ; 2hrs Note1

Note1:Condition of image sticking test :25°C±2°C

Operation with test pattern sustained for 4hrs,then change to gray pattern immediately.after5 mins,the mura must be disappeared completely

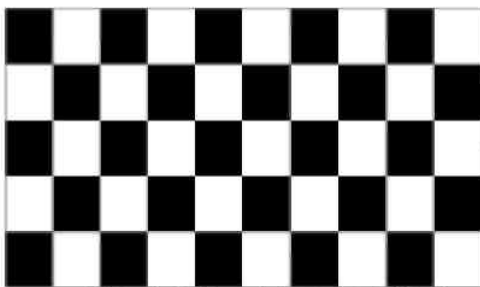

(a) Test Pattern (chess board Pattern)

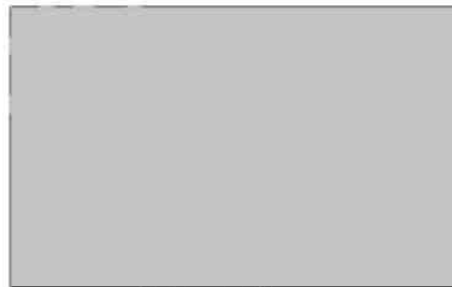

(b) Gray Pattern

8.2 VIBRATION & SHOCK

Test item	Conditions
Packing Shock (non-operation)	Shock level:980m/s ² Waveform:1/2 Sine wave,6msec ±X, ±Y ±Z,each axis 1 times
Packing Vibration (non-operation)	Frequency range:8 HZ~33.3HZ Stroke:1.0mm,sweep:10 HZ ~50 HZ x,y,z 2 hours for each direction

8.3 ESD

Test item	Conditions
Electro Static Discharge Test (non-operation)	150pF,330 Ω , Contact±4KV,Air : ±8KV Note 1
	200pF,0 Ω , ± 200V Contact test.Note 2

Note1:LCD glass and metal bezel

Note2:IF connector pins

9. GENERAL PRECAUTION

9.1 SAFETY

- (1) Do not swallow any liquid crystal, even if there is no proof that liquid crystal is poisonous.
- (2) If the LCD panel breaks, be careful not to get liquid crystal to touch your skin.
- (3) If skin is exposed to liquid crystal, wash the area thoroughly with alcohol or soap.

9.2 STORAGE CONDITIONS

- (1) Store the panel or module in a dark place where the temperature is $23\pm 5^{\circ}\text{C}$ and the humidity is below $50\pm 20\%\text{RH}$.
- (2) Store in anti-static electricity container.
- (3) Store in clean environment, free from dust, active gas, and solvent.
- (4) Do not place the module near organics solvents or corrosive gases.
- (5) Do not crush, shake, or jolt the module.

9.3 HANDLING PRECAUTIONS

- (1) Avoid static electricity which can damage the CMOS LSI.
- (2) The polarizing plate of the display is very fragile. So, please handle it very carefully.
- (3) Do not give external shock.
- (4) Do not apply excessive force on the surface.
- (5) Do not wipe the polarizing plate with a dry cloth, as it may easily scratch the Surface of plate.
- (6) Do not use ketonics solvent & Aromatic solvent, use with a soft cloth soaked with a cleaning naphtha solvent.
- (7) Do not operate it above the absolute maximum rating.
- (8) Do not remove the panel or frame from the module.
- (9) When the module is assembled, it should be attached to the system firmly, Be careful not to twist and bend the module.
- (10) Wipe off water droplets or oil immediately. If you leave the droplets for a long time, staining and discoloration may occur.
- (11) If the liquid crystal material leaks from the panel, it should be kept away from the eyes or mouth. In case of contact with hands, legs or clothes, it must be washed away thoroughly with soap.

9.4 WARRANTY

- (1) The period is within twelve months since the date of shipping out under normal using and storage conditions.
- (2) Do not repaired or modified the LCM . It may cause function to lose efficacy , Starry does not warrant the LCM.
- (3) All process and material comply RoHS.

10. PACKAGE DRAWING

TBD